



Ethernet Switches

AP9224110

AP9224111

AP9224112

Installation, Troubleshooting,
Specifications





This manual is available in English on the enclosed CD.

Ce manuel est disponible en français sur le CD-ROM ci-inclus.

Dieses Handbuch ist in Deutsch auf der beiliegenden CD-ROM verfügbar.

Questo manuale è disponibile in italiano nel CD-ROM allegato.

本マニュアルの日本語版は同梱の CD-ROM からご覧になれます。

O manual em Português está disponível no CD-ROM em anexo.

Este manual está disponible en español en el CD-ROM adjunto.

Contents

Introduction	1
Product Features and Package Contents	1
Overview	1
Features	1
Package Contents	2
Installation	3
Desktop installation	3
Rack-mounted installation	3
Power On	4
Connecting the switch	4
Installing a mini-GBIC (SFP) transceiver	5
Removing a mini-GBIC (SFP) transceiver	5
Hardware	6
24-Port 10/100 Switch	6
Front Panel	6
Rear Panel	7
24-Port 10/100 Switch with 2 Gigabit Uplink	8
Front Panel	8
Rear Panel	10
24-Port 10/100/1000 Switch with 2 Gigabit Uplink	11
Front Panel	11
Rear Panel	13
Troubleshooting	14
How to Resolve Problems	14

Specific Problems and Their Solutions. 15
 Diagnosing LED Indicator 15
 Power 15
 Incorrect connections 15
 Transmission Mode 16

Technical Specifications 17

24-Port 10/100 Switch (AP9224110) 17
24-Port 10/100 Switch with 2 Gigabit Uplink (AP9224111) 19
24-Port 10/100/1000 Switch with 2 Gigabit Uplink (AP9224112) . 21

Introduction

Product Features and Package Contents

Overview

The APC Ethernet Switch product line provides multi-port switches that can be used to create high-speed backbone connections among switches, servers, databases, and end stations. The switches fit into any enterprise-level network as an exit to the backbone switch.

This document describes the following:

- 24-Port 10/100 Switch (AP9224110)
- 24-Port 10/100 Switch with 2 Gigabit Uplink (AP9224111)
- 24-Port 10/100/1000 Switch with 2 Gigabit Uplink (AP9224112)

Features

Each switch features;

- Automatic MDI/MDIX for all ports
- N-way Auto-negotiation
- Store-and-Forward architecture
- 1U 19-inch rack-mount design
- Internal power supply
- Integrated ventilation fan (AP9224112 only)

Package contents

- One APC Ethernet Switch
- Power cord
- Four rubber feet
- Rack mount kit
- User's Guide

Compare the contents of your Ethernet switch package with the checklist above. If any item is missing or damaged, contact “APC Worldwide Customer Support” using the phone numbers on the back cover of this guide.

Installation

Desktop installation

Place the switch on a large, clean, level surface with a power outlet nearby. Make sure there is enough clearance around the switch for attaching cables and the power cord, and for air circulation.

Attaching rubber feet.

1. Make sure the mounting surface on the bottom of the switch is free of grease and dust.
2. Remove the adhesive backing from the rubber feet.
3. Apply one rubber foot to each corner on the bottom of the switch to protect the switch from shocks and vibrations.

Rack-mounted installation

The switch comes with a rack-mount kit and can be mounted in an EIA standard size, 19-inch rack. The switch can be placed in a wiring closet with other equipment.

To mount the switch in a rack:

1. Position one bracket to align with the holes on one side of the switch and secure it with the smaller bracket screws. Attach the remaining bracket to the other side of the switch.

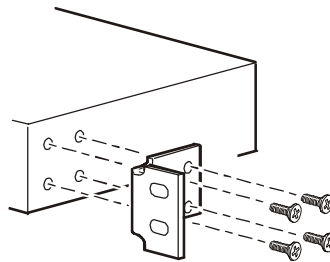

2. Position the switch in the rack by aligning the holes in the brackets with the appropriate holes on the rack. Secure the switch to the rack with the rack-mounting screws.

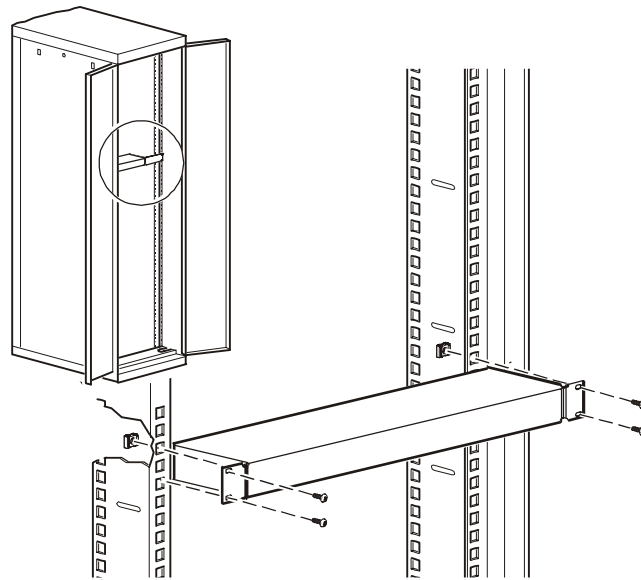

Applying power

Connect the cord of the power adapter to the power socket on the rear panel of the switch. Connect the other end of the power cord to an APC UPS that is connected to a power outlet. Check the power indicator on the front panel to make sure that the switch is receiving power.



Note

After you connect the power cord of an AP9224112, use the power switch on the rear panel to supply power to the unit.

Connecting the switch

The RJ-45 ports use either unshielded twisted-pair (UTP) or shielded twisted-pair (STP) cable.

- For 10 Mbps connections use 100 Ω Category 3, 4, or 5 cable
- For 100 Mbps connections use 100 Ω Category 5 cable
- For 1000 Mbps connections use 4-pair Category 5 copper cabling



Note

The length of any twisted-pair connection must not exceed 328 feet (100 meters).

Installing a mini-GBIC (SFP) transceiver

To install a mini-GBIC (SFP) transceiver:

1. Insert the transceiver into the mini-GBIC port with the exposed section of PCB board facing down.
2. Push the transceiver firmly until it clicks into place.
3. The switch automatically detects the installed transceiver. Check the LEDs to verify that it is functioning properly.

Removing a mini-GBIC (SFP) transceiver

To remove a mini-GBIC (SFP) transceiver from the mini-GBIC port:

1. Remove the fiber-optic cables from the transceiver.
2. Unlock the transceiver's latch (latch styles vary).
3. Pull the transceiver out of the mini-GBIC port.
4. Put the dust cover on the transceiver.

Hardware

24-Port 10/100 Switch

Front panel of the AP9224110 switch

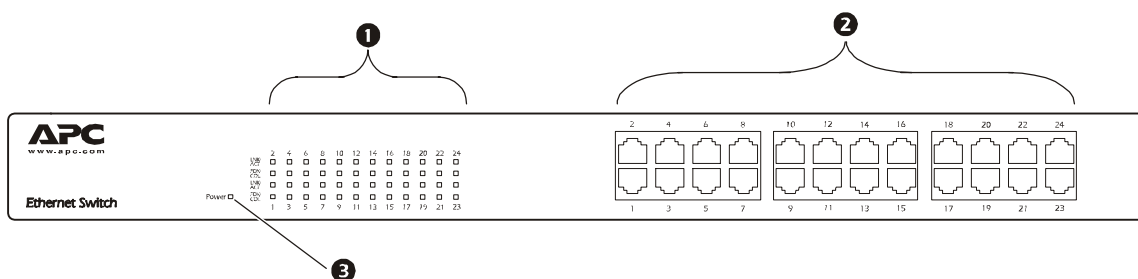

- ❶ LED indicators (two for each RJ-45 port)
- ❷ 24 10/100Base-TX RJ-45 ports
- ❸ One Power LED indicator

LED Indicators. The LED indicators provide real-time information on the system's operating status.

LED	Status	Description
Power	Green	Power is on.
	Off	Power is not connected.
LNK/ACT	Green	The port is connecting with the device.
	Blinking	The port is receiving or transmitting data.
	Off	No device is attached.
FDX/COL	Orange	The port is operating in full-duplex mode.
	Blinking	Packet collision occurred on this port.
	Off	No device is attached or the port is operating in half-duplex mode.

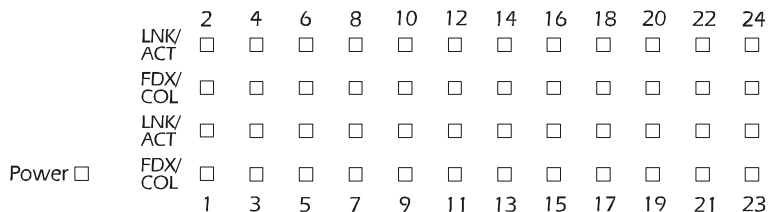

Rear Panel

The power input connector is located on the rear panel of the switch.

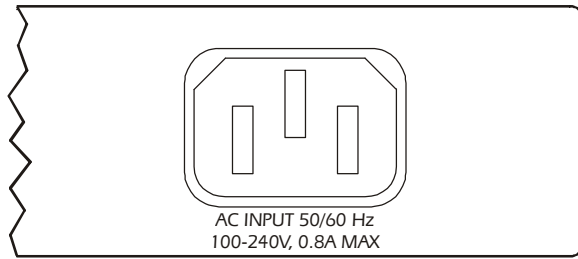

24-Port 10/100 Switch with 2 Gigabit Uplink

Front panel of the AP9224111 switch

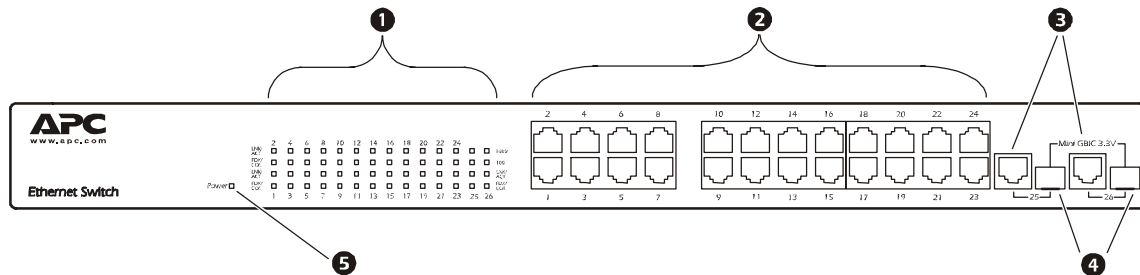

- ❶ LED indicators for each RJ-45 port
- ❷ 24 10/100Base-TX RJ-45 ports
- ❸ Two auto-detect gigabit ports
- ❹ Two mini-GBIC (Small Form Factor Plug-in) ports
- ❺ One Power LED indicator

Mini-GBIC (SFP) ports. Mini-GBIC (SFP) transceivers use the separate mini-GBIC (SFP) ports.



When you install the mini-GBIC (SFP) transceiver into the port on the switch, you must disconnect any device connected to its partner gigabit copper port of the same number. If the gigabit copper port is occupied, the switch will not detect the mini-GBIC (SFP) that you installed.

LED Indicators . Two LED indicators for each RJ-45 port and a power LED for each unit provide real-time information on the system’s operating status.

LED	Status	Description
Power	Green	Power is on.
	Off	Power is not connected.
LNK/ACT	Green	The port is connecting with the device.
	Blinking	The port is receiving or transmitting data.
	Off	No device is attached.
FDX/COL	Orange	The port is operating in full-duplex mode.
	Blinking	Packet collision occurred on this port.
	Off	The port is operating in half-duplex mode.

Gigabit port LEDs. Each Gigabit port has the following LEDs.

LED	Status	Description
1000 (Gigabit port)	Green	The port is operating at 1000mbps
100 (Gigabit port)	Orange	The port is operating at 100mbps
LNK/ACT (Gigabit port)	Green	The port is connecting with the device.
	Blinking	The port is receiving or transmitting data.
	Off	No device is attached.
FDX/COL (Gigabit port)	Orange	The port is operating in full-duplex mode.
	Blinking	Packet collision occurred on this port.
	Off	The port is operating in half-duplex mode.

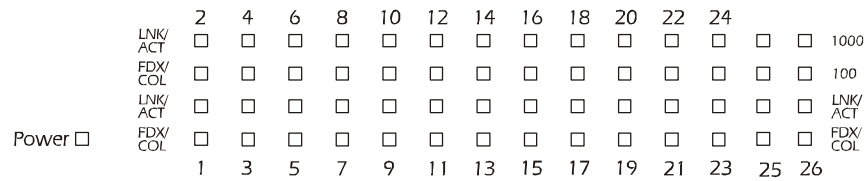

Rear panel

The power input connector is located on the rear panel of the switch.

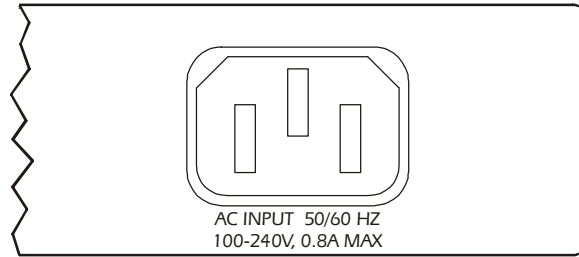

24-Port 10/100/1000 Switch with 2 Gigabit Uplink

Front panel of the AP9224112 switch

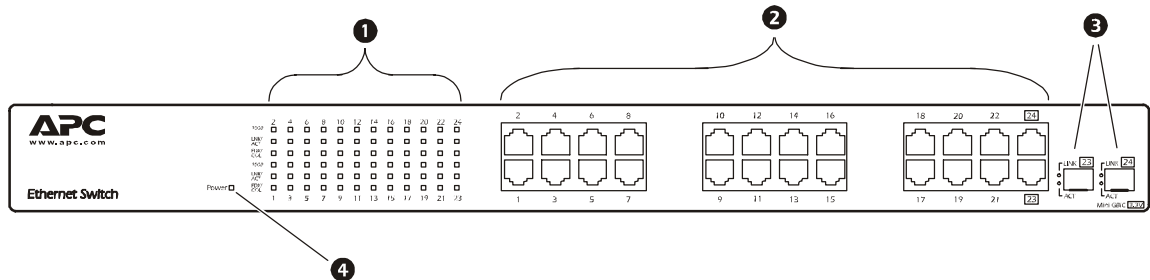

- ❶ LED indicators (three for each RJ-45 port)
- ❷ 24 10/100/1000mbps Ethernet RJ-45 ports
- ❸ Two Mini-GBIC (SFP) ports
- ❹ One Power LED indicator

Mini-GBIC (SFP) ports. Mini-GBIC (SFP) transceivers use the separate ports 23 and 24. The switch auto-detects between Gigabit copper and mini-GBIC (Giga fiber) connections.



Note

When a mini-GBIC (SFP) transceiver is installed, the mini-GBIC (SFP) ports have higher priority than the Giga copper ports 23 and 24.

When mini-GBIC (SFP) transceivers are not installed, ports 23 and 24 are Gigabit copper only.



See “Mini GBIC (SFP) LEDs” on page 13

LED Indicators . The LED indicators provide real-time information on the system’s operating status. There are three LED indicators for each RJ-45 port and a power LED for each unit.

LED	Status	Description
Power	Green	Power is on.
	Off	Power is not connected.
1000	Green	The port is operating at 1000mbps.
	Off	No device is attached or the device is operating in 10/100mbps mode.
LNK/ACT	Green	The port is connecting with the device.
	Blinking	The port is receiving or transmitting data.
	Off	No device is attached.
FDX/COL	Orange	The port is operating in full-duplex mode.
	Blinking	Packet collision occurred on this port.
	Off	No device is attached or the port is operating in half-duplex mode.

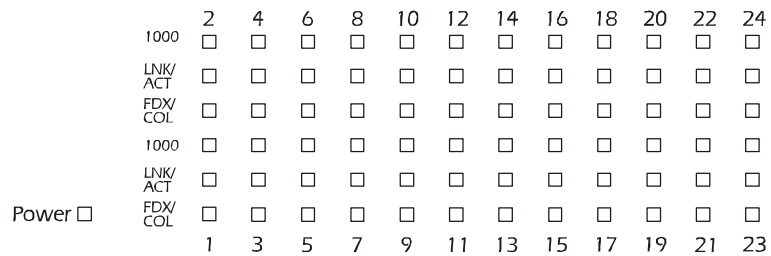

Mini GBIC (SFP) LEDs. Each mini-GBIC (SFP) port has one LNK and one ACT LED indicator.

LED	Status	Description
LNK	Green	The port is connecting with the device.
	Off	No device is attached.
ACT	Green (Blinking)	The port is transmitting or receiving data.
	Off	No data is being transmitted or received.

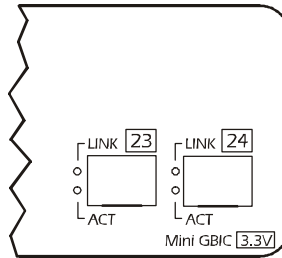

Rear Panel

The power input connector, on/off switch, and ventilation fan are located on the rear panel of the switch.

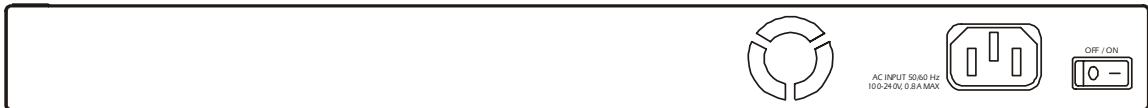

Troubleshooting

How to Resolve Problems

This chapter describes common problems that may occur when using the switch and their possible solutions.

First, use the information in this chapter to attempt to resolve a problem. If you cannot resolve the problem, contact APC Worldwide Customer Support using the numbers listed on the back cover of this guide.

Specific Problems and Their Solutions

Diagnosing LED Indicator

If the LNK LED does not illuminate after connection, check the following:

- Verify that the switch and any devices attached to it are turned on.
- Be sure the connecting cable is plugged into both the switch and its corresponding device.
- Verify that the proper cable type is used and its length does not exceed specified limits.



See “Connecting the switch” on page 4

Power

If the power indicator on the front panel of the switch does not turn on when the power cord is plugged in, the power outlet or power cord may be defective. Check to see that the power switch on the rear panel is turned on (AP9224112 only.)

If the switch loses power after running for a while, check for loose power connections, or power fluctuations at the power outlet.

Incorrect connections

The switch can auto-detect whether a device is connected with a straight-through or crossover cable. If the RJ-45 connector pins are not properly configured, the link will fail. For a mini-GBIC connection, make sure the fiber cable mode matches the mini-GBIC (SFP) transceiver.

Faulty or loose cables. Look for loose or faulty connections. Make sure the connections are snug. If that does not correct the problem, try a different cable of the same category.

Non-standard cables. Check that you are using the correct cables.



See “Connecting the switch” on page 4.

Improper network topologies. Make sure that you are using a valid network topology. Too many hubs or repeaters between the connected computers in the network may increase the number of packet collisions or cause other network problems. Remove unnecessary hubs from the network.

Data path loops. Check for data path loops. There should be only one active cabling path at any time between any two ends nodes.

Transmission Mode

The RJ-45 ports use auto-negotiation to set the transmission mode to either full-duplex or half-duplex.

Verify that each port is set to the same transmission mode used by the attached device. If the attached device operates at half-duplex, the default when auto-negotiation fails, it does not support auto-negotiation.

Technical Specifications

24-Port 10/100 Switch (AP9224110)

Performance

Transfer Rate	14,880 packets per second for 10mbps 148,800 packets per second for 100mbps
MAC Address	4K MAC address table
Memory Buffer	1.25mbits
Backplane	4.8gbps

Electrical

Input connector	IEC-320-C14
Nominal input voltage	100 – 240VAC
Input frequency	50 – 60Hz
Power Consumption	18 Watts (Maximum)

Communication and Management

Protocol	CSMA/CD
Technology	Store-and-Forward switching architecture
LED	System: Power Per RJ-45 port: Link/Activity, Full-duplex/Collision

Physical

Size (H x W x D)	1.73 x 17.32 x 4.72 in (44 x 440 x 120 mm)
Connector	RJ-45: 24 ports
Network Cable	10BASE-T: 2 pairs UTP/STP CAT3, CAT4, or CAT5 cable EIA/TIA 568 100 Ω (100M) 100BASE-TX: 2 pairs UTP/STP CAT5 cable EIA/TIA 568 100 Ω (100M)

Environmental

Temperature

Operating	0° C to 45° C (32° F to 113° F)
Storage	-10° C to 70° C (-14° F to 158° F)

Humidity

Operating	10% to 95% (Non-condensing)
Storage	10% to 95%

Compliance

Standard	IEEE 802.1p CoS IEEE 802.3 10BASE-T IEEE 802.3u 100BASE-TX IEEE 802.3x Flow control
----------	--

Regulatory Approvals

Product Safety	cUL, UL, 60950, EN60950, TÜV
EMC	FCC part 15, EN55022, VCCI Class A, EN55024, EN 61000-3-2, EN 61000-3-3

24-Port 10/100 Switch with 2 Gigabit Uplink (AP9224111)

Performance

Transfer Rate	14,880 packets per second for 10mbps 148,800 packets per second for 100mbps 1,488,000 packets per second for 1000mbps
MAC Address	8K MAC address table
Memory Buffer	2.5mbits
Backplane	8.8gbps

Electrical

Input connector	IEC-320-C14
Nominal input voltage	100 – 240 VAC
Input frequency	50 – 60Hz
Power Consumption	20 Watts (Maximum)

Communication and Management

Protocol	CSMA/CD
Technology	Store-and-Forward switching architecture
LED	System: Power Per RJ-45 port: Link/Activity, Full-duplex/Collision Per Giga port: 100, 1000, Link/Activity, Full-duplex/Collision Per mini-GBIC port: Link/Activity

Physical

Size (H x W x D)	1.73 x 17.32 x 6.34 in (44 x 440 x 161 mm)
Connector	RJ-45: 24 ports Mini GBIC: 2 x 3.3V mini-GBIC slots
Network Cable	10BASE-T: 2 pairs UTP/STP CAT3, CAT4, or CAT5 cable EIA/TIA 568 100Ω (100M) 100BASE-TX: 2 pairs UTP/STP CAT5 cable EIA/TIA 568 100Ω (100M) Gigabit Copper: 4 pairs UTP/STP CAT5 cable EIA/TIA 568 100Ω (100M)

Environmental

Temperature

Operating	0°C to 45°C (32°F to 113°F)
Storage	-10°C to 70°C (-14°F to 158°F)

Humidity

Operating	10% to 95% (Non-condensing)
Storage	10% to 95%

Compliance

Standard	IEEE 802.1p CoS IEEE 802.3 10BASE-T IEEE 802.3u 100BASE-TX IEEE 802.3ab 1000Base-T IEEE 802.3x Flow control (not supported on mini-GBIC ports)
----------	--

Regulatory Approvals

Product Safety	cUL, UL, 60950, EN60950, TÜV
EMC	FCC part 15, EN55022, VCCI Class A, EN55024, EN 61000-3-2, EN 61000-3-3

24-Port 10/100/1000 Switch with 2 Gigabit Uplink (AP9224112)

Performance

Transfer Rate	14,880 packets per second for 10mbps 148,800 packets per second for 100mbps 1488000 packets per second for 1000mbps
MAC Address	4K MAC address table
Memory Buffer	2mbits

Electrical

Input connector	IEC-320-C14
Nominal input voltage	100 – 240VAC
Input frequency	50 – 60Hz
Power Consumption	60Watts (Maximum)

Communication and Management

Protocol	CSMA/CD
Technology	Store-and-Forward switching architecture
LED	System: Power Per RJ-45 port: 1000mbps, Link/Activity, Full-duplex/Collision Per Mini-GBIC port: Link/Activity

Physical

Size (H x W x D)	1.73 x 17.32 x 8.82 in (44 x 440 x 224 mm)
Connector	RJ-45: 26 ports Mini GBIC: 2 x 3.3 V mini-GBIC slots
Network Cable	10BASE-T: 2 pairs UTP/STP CAT3, CAT4, or CAT5 cable EIA/TIA 568 100Ω (100M) 100BASE-TX: 2 pairs UTP/STP CAT5 cable EIA/TIA 568 100Ω (100M) Gigabit Copper: 4 pairs UTP/STP CAT5 cable EIA/TIA 568 100Ω (100M)

Environmental

Temperature

Operating	0°C to 45°C (32° F to 113° F)
Storage	-10°C to 70°C (-14° F to 158° F)

Humidity

Operating	10% to 95% (Non-condensing)
Storage	10% to 95%

Compliance

Standard	IEEE 802.1p CoS
	IEEE 802.3 10BASE-T
	IEEE 802.3u 100BASE-TX
	IEEE 802.3z Gigabit fiber
	IEEE 802.3ab 1000Base-T
	IEEE 802.3x Flow control

Regulatory Approvals

Product Safety	cUL, UL, 60950, EN60950, TÜV
EMC	FCC part 15, EN55022, VCCI Class A, EN55024, EN 61000-3-2, EN 61000-3-3

Radio Frequency Interference



Changes or modifications to this unit not expressly approved by the party responsible for compliance could void the user's authority to operate this equipment.

USA—FCC

This equipment has been tested and found to comply with the limits for a Class A digital device, pursuant to part 15 of the FCC Rules. These limits are designed to provide reasonable protection against harmful interference when the equipment is operated in a commercial environment. This equipment generates, uses, and can radiate radio frequency energy and, if not installed and used in accordance with this user manual, may cause harmful interference to radio communications. Operation of this equipment in a residential area is likely to cause harmful interference. The user will bear sole responsibility for correcting such interference.

Canada—ICES

This Class A digital apparatus complies with Canadian ICES-003.

Cet appareil numérique de la classe A est conforme à la norme NMB-003 du Canada.

Japan—VCCI

This is a Class A product based on the standard of the Voluntary Control Council for Interference by Information Technology Equipment (VCCI). If this equipment is used in a domestic environment, radio disturbance may occur, in which case, the user may be required to take corrective actions.

この装置は、情報処理装置等電波障害自主規制協議会（VCCI）の基準に基づくクラス A 情報技術装置です。この装置を家庭環境で使用すると、電波妨害を引き起こすことがあります。この場合には、使用者が適切な対策を講ずるように要求されることがあります。

APC Worldwide Customer Support

Customer support for this or any other APC product is available at no charge in any of the following ways:

- Visit the APC Web site to access documents in the APC Knowledge Base and to submit customer support requests.
 - **www.apc.com** (Corporate Headquarters)
Connect to localized APC Web sites for specific countries, each of which provides customer support information.
 - **www.apc.com/support/**
Global support searching APC Knowledge Base and using e-support.
- Contact an APC Customer Support center by telephone or e-mail.
 - Regional centers:

Direct InfraStruXure Customer Support Line	(1)(877)537-0607 (toll free)
APC headquarters U.S., Canada	(1)(800)800-4272 (toll free)
Latin America	(1)(401)789-5735 (USA)
Europe, Middle East, Africa	(353)(91)702000 (Ireland)
Japan	(0) 35434-2021
Australia, New Zealand, South Pacific area	(61) (2) 9955 9366 (Australia)

- Local, country-specific centers: go to **www.apc.com/support/contact** for contact information.

Contact the APC representative or other distributor from whom you purchased your APC product for information on how to obtain local customer support.

Entire contents copyright © 2004 American Power Conversion. All rights reserved.
Reproduction in whole or in part without permission is prohibited. APC and the APC logo are trademarks of American Power Conversion Corporation and may be registered in some jurisdictions. All other trademarks, product names, and corporate names are the property of their respective owners and are used for informational purposes only.

